

GB



*Powercut*TM 900



Instruction manual

DECLARATION OF CONFORMITY

acc. to the EC Low Voltage Directive 2006/95 EEC, acc. to the EC EMC Directive 2004/108 EEC

FÖRSÄKRAN OM ÖVERENSSTÄMMELSE

enligt lågspänningsdirektivet 2006/95 EEG, enligt EMC-direktivet 2004/108 EEG

Fill in and put a cross in appropriate boxes Fyll i och kryssa tillämpliga rutor

Type of equipment Materialslag

Plasma Cutting power source

Brand name or trade mark Fabrikatnamn eller varumärke

ESAB

Type designation etc. Typbeteckning etc.

Powercut 900 from Serial No. 040 xxx xxxx

Manufacturer's name, address, telephone No, telefax No: Tillverkarens namn, adress, telefon, telefax:

OZAS-ESAB Sp. z o.o.

ul. Struga 10 45-073 Opole, POLAND

Phone: +48 77 40-19-200, Fax: +48 77 40-19-201

Manufacturer's authorised representative established within the EEA; Name, address, telephone No, telefax No:

Tillverkarens representant inom EES; Namn, adress, telefon, telefax:

ESAB AB Arc Equipment

Esabvägen, 695 81 Laxå, SWEDEN

Phone: +46 584 81 000, Fax: +46 584 411 924

The following harmonised standards or technical specifications (designations) which comply with good engineering practice in safety matters in force within the EEA have been used in the design:

Följande harmoniserande standarder eller tekniska specifikationer (beteckningar) som uppfyller god säkerhetsteknisk praxis inom EES har använts i konstruktionen:

EN 60 974-1 Arc welding equipment -

Part 1: Welding power sources

EN 60 974-10 Electromagnetic compatibility (EMC) -

Product standard for arc welding equipment

1. The equipment conforms completely with the above stated harmonised standards or technical specifications.

Materielen överensstämmer helt med ovan angivna harmoniserade standarder eller tekniska specifikationer.

OR ELLER

2. The equipment conforms only partially with the above stated harmonised standards or technical specifications but complies with good engineering practice in safety matters in force within the EEA.

Materielen överensstämmer endast delvis med ovan angivna harmoniserade standarder eller tekniska specifikationer men uppfyller god säkerhetsteknisk praxis inom EES.

Additional information Övriga uppgifter

By signing this document, the undersigned declares as manufacturer, or the manufacturer's authorised representative established within the EEA, that the equipment in question complies with the safety requirements stated above.

Genom att underteckna detta dokument försäkras undertecknad såsom tillverkare, eller tillverkarens representant inom EES, att angiven materiel uppfyller säkerhetskraven angivna ovan.

Manufacturer
Tillverkare

or
eller

Manufacturer's authorised representative
Tillverkarens representant

Date Datum
Opole 14.12.2010

Position Befattning
Managing Director

Signature Underskrift

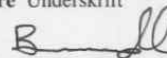

Clarification namnförtydligande

Dariusz Brudkiewicz

1 SAFETY	4
2 INTRODUCTION	6
2.1 Equipment	6
3 TECHNICAL DATA	6
4 INSTALLATION	7
4.1 Delivery check and location	8
4.2 Mains power supply	9
4.3 Input air connection	9
4.4 Connection for return cable	10
4.5 Connection of torch	11
5 OPERATION	12
5.1 Connections	12
5.2 Control devices	13
5.2.1 Symbol key	14
5.3 Cutting	15
6 MAINTENANCE	16
6.1 Inspection and cleaning	16
7 FAULT TRACING	17
7.1 Fault codes	18
8 ORDERING SPARE PARTS	19
DIAGRAM	20
ORDERING NUMBER	24
ACCESSORIES	25

1 SAFETY

Users of ESAB equipment have the ultimate responsibility for ensuring that anyone who works on or near the equipment observes all the relevant safety precautions. Safety precautions must meet the requirements that apply to this type of equipment. The following recommendations should be observed in addition to the standard regulations that apply to the workplace.

All work must be carried out by trained personnel well-acquainted with the operation of the equipment. Incorrect operation of the equipment may lead to hazardous situations which can result in injury to the operator and damage to the equipment.

1. Anyone who uses the equipment must be familiar with:
 - its operation
 - location of emergency stops
 - its function
 - relevant safety precautions
 - welding and cutting
2. The operator must ensure that:
 - no unauthorised person is stationed within the working area of the equipment when it is started up.
 - no-one is unprotected when the arc is struck
3. The workplace must:
 - be suitable for the purpose
 - be free from drafts
4. Personal safety equipment
 - Always wear recommended personal safety equipment, such as safety glasses, flame-proof clothing, safety gloves.
 - Do not wear loose-fitting items, such as scarves, bracelets, rings, etc., which could become trapped or cause burns.
5. General precautions
 - Make sure the return cable is connected securely.
 - Work on high voltage equipment **may only be carried out by a qualified electrician.**
 - Appropriate fire extinguishing equipment must be clearly marked and close at hand.
 - Lubrication and maintenance must **not** be carried out on the equipment during operation.



WARNING



Arc welding and cutting can be injurious to yourself and others. Take precautions when welding and cutting. Ask for your employer's safety practices which should be based on manufacturers' hazard data.

ELECTRIC SHOCK - Can kill

- Install and earth the unit in accordance with applicable standards.
- Do not touch live electrical parts or electrodes with bare skin, wet gloves or wet clothing.
- Insulate yourself from earth and the workpiece.
- Ensure your working stance is safe.

FUMES AND GASES - Can be dangerous to health

- Keep your head out of the fumes.
- Use ventilation, extraction at the arc, or both, to take fumes and gases away from your breathing zone and the general area.

ARC RAYS - Can injure eyes and burn skin.

- Protect your eyes and body. Use the correct welding screen and filter lens and wear protective clothing.
- Protect bystanders with suitable screens or curtains.

FIRE HAZARD

- Sparks (spatter) can cause fire. Make sure therefore that there are no inflammable materials nearby.

NOISE - Excessive noise can damage hearing

- Protect your ears. Use earmuffs or other hearing protection.
- Warn bystanders of the risk.

MALFUNCTION - Call for expert assistance in the event of malfunction.

Read and understand the instruction manual before installing or operating.

PROTECT YOURSELF AND OTHERS!



WARNING

Do not use the power source for thawing frozen pipes.



CAUTION

Class A equipment is not intended for use in residential locations where the electrical power is provided by the public low-voltage supply system. There may be potential difficulties in ensuring electromagnetic compatibility of class A equipment in those locations, due to conducted as well as radiated disturbances.

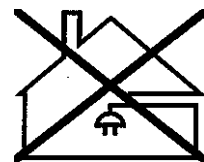

CAUTION

This product is solely intended for plasma cutting.



CAUTION

Read and understand the instruction manual before installing or operating.

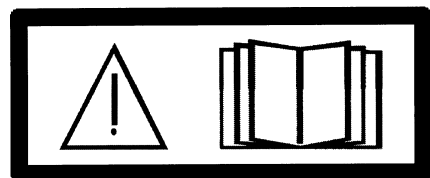

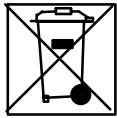

Dispose of electronic equipment at the recycling facility!

In observance of European Directive 2002/96/EC on Waste Electrical and Electronic Equipment and its implementation in accordance with national law, electrical and/or electronic equipment that has reached the end of its life must be disposed of at a recycling facility.

As the person responsible for the equipment, it is your responsibility to obtain information on approved collection stations.

For further information contact the nearest ESAB dealer.

ESAB can provide you with all necessary cutting protection and accessories.

2 INTRODUCTION

The plasma power source **Powercut 900** and the plasma cutting torch **PT-38** are a complete and safe plasma cutting system for manual cutting and gouging. It delivers cutting power for severing materials up to 32 mm thickness.

ESAB's accessories for the product can be found on page 25.

2.1 Equipment

The power source is supplied with:

- mains cable, 3 m
- instruction manual
- return cable incl clamp
- plasma cutting torch PT 38, 7.5 m, supplied according to the denomination on page 24.

3 TECHNICAL DATA

Powercut 900	
Mains voltage	3 x 230 V, 400 V ± 10 % 50/60 Hz
Mains supply	Ssc min. 4.0 MVA Zmax. 0.04 Ω
Setting range	20 – 60 A
Permitted load	60 A / 120 V 50 A / 120 V
60 % duty cycle	
100 % duty cycle	
Efficiency at maximum current	87 %
Open-circuit voltage U ₀	290 V
Operating temperature	-10 to 40 °C
Transportation temperature	-20 to 55 °C
Sound pressure at no load	< 70 db (A)
Dimensions, l x w x h	630x 322 x 379 mm
Weight	35 kg
Insulation class transformer	H
Enclosure class	IP 23

**Mains supply, $S_{sc \text{ min}}$**

Minimum short circuit power on the network in accordance with IEC 61000-3-12

Mains supply, Z_{max}

Maximum permissible line impedance of the network in accordance with IEC 61000-3-11.

Duty cycle

The duty cycle refers to the time as a percentage of a ten-minute period that you can weld or cut at a certain load without overloading. The duty cycle is valid for 40° C.

Enclosure class

The IP code indicates the enclosure class, i. e. the degree of protection against penetration by solid objects or water. Equipment marked IP23 is designed for indoor and outdoor use.

4 INSTALLATION

The installation must be carried out by a professional.

Correct installation is very important for trouble-free operation and good cutting results. Carefully read and follow each step in this chapter.

**WARNING**

ELECTRIC SHOCKS CAN KILL Take precautionary measures against electric shocks. Ensure that all power supplies are disconnected – switch off the switch at the wall socket and pull out the equipment's power cable from the socket before making any electrical connections in the power source.

**WARNING**

It is very important that the chassis is connected to the approved electric protective earth, to prevent electric shocks and electrical accidents. Ensure that protective earth is not connected to any phase conductors by mistake.

**WARNING**

Poor connections or failure to connect the return cable to the workpiece can result in fatal electric shock.

**WARNING**

Air filter devices may not be used – installation or mounting of any form of air filter device prevents the cold air flow and causes a risk of overheating. The warranty is invalidated if any type of air filter is used.



WARNING

*Do NOT start the equipment with the cover removed.
Do NOT connect the equipment under tension or when you are holding it or carrying it.
Do NOT touch any of the torch's parts when the power supply is on.*



CAUTION

This product is intended for industrial use. In a domestic environment this product may cause radio interference. It is the user's responsibility to take adequate precautions.



CAUTION

Place the power source at least 3 metres from the cutting area as sparks and slag spray can damage the power source

4.1 Delivery check and location

1. Remove the packaging. Inspect the equipment for damage that was not immediately apparent upon reception of the delivery. Immediately report any damage to the delivery company.
2. Check for any loose parts in the packaging. Check that the air ducts in the cover's rear panel are not blocked with packaging material that can prevent the air flow through the power source.

The power source has a lifting eyelet and can be lifted easily. Check that the lifting equipment that is to be used can withstand the weight of the power source. The weight is stated in the table TECHNICAL DATA, see chapter 3.



WARNING

The product must be lifted as follows:



3. Position the power source so that its cooling air inlets and outlets are not obstructed. Minimum permitted distance to wall or other obstruction is 30 cm.
4. An air source that gives clean and dry air, at least 236 l/m at 6.2 bar (90 psig), is required for cutting. The cutting air pressure must not exceed 10.3 bar (150 psig), which is the maximum inlet pressure for the filter regulator that is included in the delivery.

4.2 Mains power supply

Make sure that the power source is connected to the correct supply voltage and that it is protected by the correct fuse rating. The outlet shall have a protective earth connection.

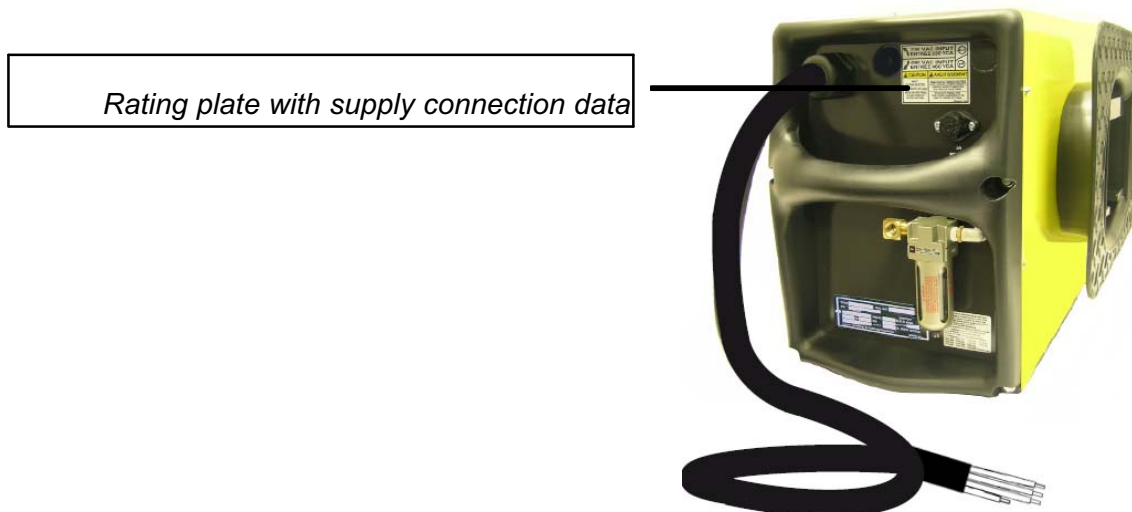

Recommended fuse sizes and minimum cable area

Powercut 900	50 Hz
Mains voltage	230 V/ 400 V
Mains cable area mm ²	4 G 6
Phase current I _{1eff}	23 A/ 14 A
Fuse, anti-surge	32 A/ 20 A

NOTE! The mains cable areas and fuse sizes as shown above are in accordance with Swedish regulations. Use the power source in accordance with the relevant national regulations.



WARNING

Make sure the power source is switched off before removing the fuse.

4.3 Input air connection

Connect your air supply to the inlet connection of the filter.

4.4 Connection for return cable

Clamp the return cable to the workpiece. Be sure the workpiece is connected to an approved earth ground with a properly sized ground cable.



4.5 Connection of torch

Open the lid on the front panel.



Connect the torch cable receptacle to the panel receptacle. Check the orientation of the sockets to ensure a correct fit.



Connect the air hose to the quick-connect fitting. Place the strain relief in the square cutout in the front.



Connect the mains cable into the plug on the front and turn it clockwise until it is secured. Put the lid back.



5 OPERATION

General safety regulations for handling the equipment can be found on page 4. Read through before you start using the equipment!

5.1 Connections

- | | | | |
|---|-----------------------------|---|-------------------------|
| 1 | Mains cable | 4 | Torch |
| 2 | Fuse (2A) | 5 | Return cable with clamp |
| 3 | Pre-filtered dry air supply | | |



5.2 Control devices

- | | | | |
|---|------------------------|---|---------------------------------|
| 1 | Power switch ON/OFF | 4 | Torch trigger/ Gas test trigger |
| 2 | Output current control | 5 | Pressure regulator |
| 3 | Display | | |

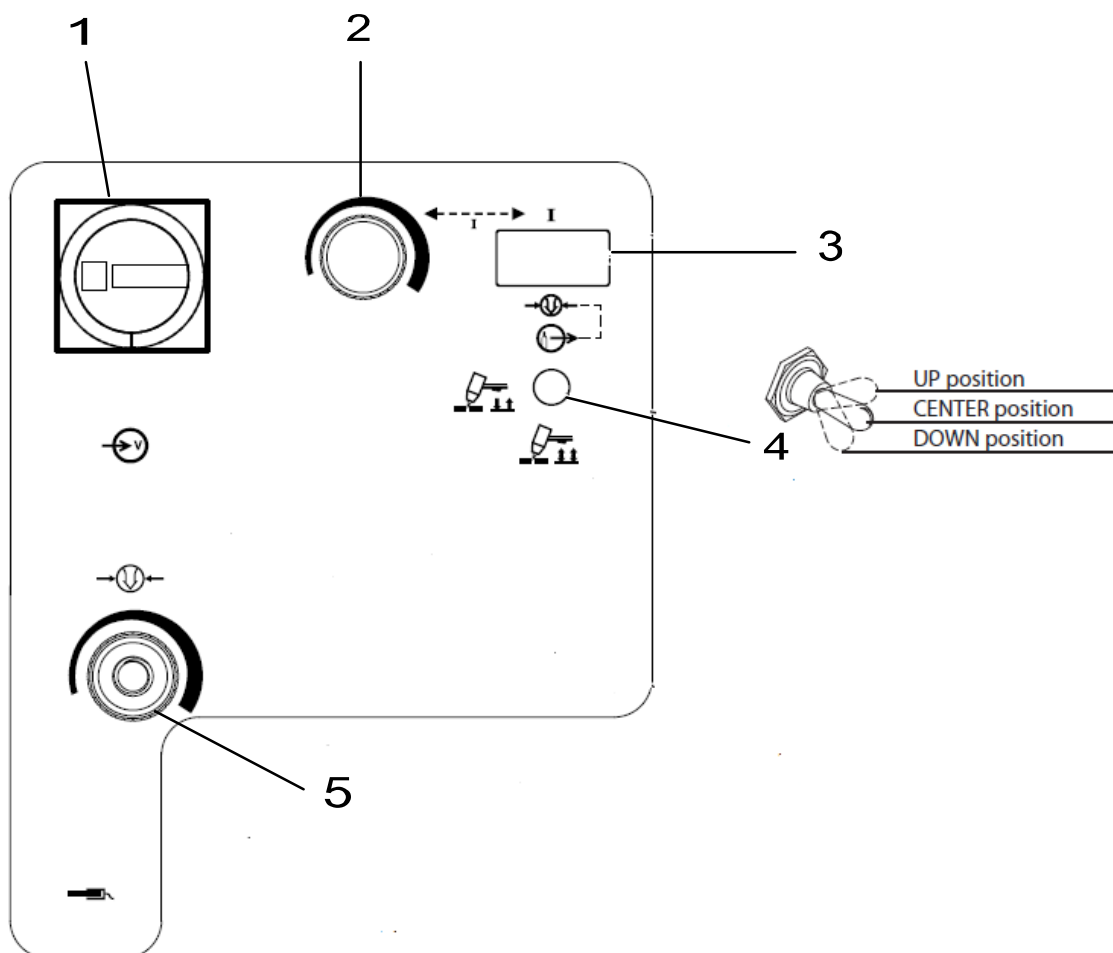

Power switch - (1)

Turn the knob clockwise to “ON” position for normal operation. Turn the knob counterclockwise to switch “OFF”.

Output current control - (2)

Adjustable from 20 to 60 A. For settings see cut data charts in the torch manual.

Display - (3)

Shows current settings during normal operation. When the unit is initially switched on, the software version will be briefly displayed.

When the unit is in the “GAS TEST” mode, the display will indicate the air pressure setting in bar. The setting can be switched to psi by service technicians.

Should a fault condition exist in the normal operation, the display will show a code number, see chapter 7.1.

Torch trigger/Gas test switch - (4)

Operating modes:

Normal trigger (CENTER position) - Setting will be used for most cutting and gouging operations. The torch switch must be held in by the operator during the entire cutting operation and then released at the end of cut. Recommended for normal cutting, expanded metal/grate cutting and gouging.

Trigger lock (DOWN position) - allows the torch switch to be released after triggering and the cutting arc has been initiated. To extinguish the arc at the end of the cut, press and release the torch switch again or pull the torch away from the work piece. Not recommended for expanded metal/grate cutting.







Test mode:

Gas test switch (UP position) - The display will indicate flowing air pressure. The air regulator should be adjusted to recommended pressure before cutting operations. Allow air to flow for a few minutes. This should remove any condensation that may have accumulated during a shutdown period. Be sure to place the switch in normal trigger or trigger lock position before starting any cutting operations.

Pressure regulator - (5)

Regulates torch air pressure. Rotate clockwise to increase and counterclockwise to decrease.

5.2.1 Symbol key

	Power (1)		Gas test (4)
	Normal trigger (4)		Trigger lock (4)
	Air pressure (5)		Return cable

NOTE! The unit is supplied from the factory with the regulator set to give 5.5 bar (80 psig) to the torch from a 6.5 bar (95 psig) supply. If the supply pressure to the unit exceeds 6.5 bar (95 psig) up to the maximum recommended 10.3 bar (150 psig), turn the pressure regulator counterclockwise to reduce the pressure to the torch to 5.5 bar (80 psig). Follow the gas testing instructions above.

5.3 Cutting

1. Set the switch (wall socket or similar) to on.
2. Check that the compressor is connected to the power source.
3. Set the mains voltage switch to I (On).
4. Flip the toggle switch upwards to gas test mode (GAS TEST). Set the pressure regulator to 5.5 bar (80 psi).
5. Set the toggle switch to normal mode (CENTER) or trigger lock mode (DOWN).
6. After starting the cut, the torch should be maintained at a 5 - 15° forward angle. This angle is especially useful in helping to create a “drop” cut. When not using the stand-off guide, the nozzle should be held approximately 3.2 mm - 6.4 mm from the work.

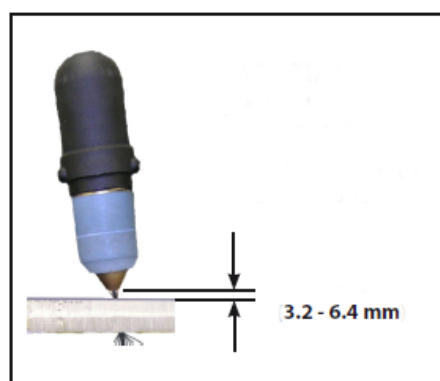
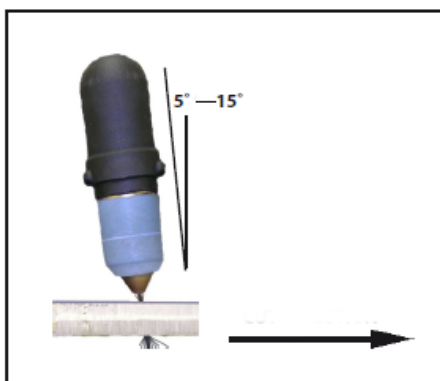

7. Depress the torch switch. Air should flow from the torch nozzle.
8. Two seconds after depressing the torch switch, the pilot arc should start. The main arc should immediately follow, allowing the cut to begin. (If using the TRIGGER LOCK feature, the torch switch may be released after establishing the cutting arc.)
9. To start a cut, tilt the torch to prevent molten material from coming back against and damaging the torch. When the arc breaks through the workpiece, bring the torch to an upright position and proceed to cut.

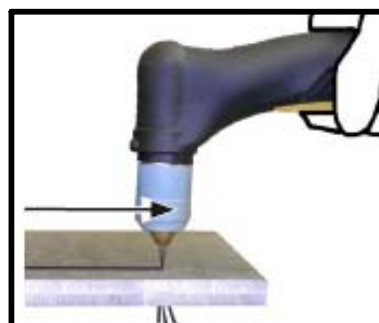

10. When ending a cut, the torch switch should be released (press and release if using TRIGGER LOCK feature) and the torch lifted off the workpiece immediately upon completion of the cut. This is to prevent the pilot arc from re-igniting after cutting arc extinguishes and causing damage to the nozzle (double arcing).
11. For rapid re-starts, such as grate or heavy mesh cutting, do not release the torch switch. In the postflow mode, the arc can be re-started immediately by depressing the torch switch. This avoids the 2-second preflow portion of the cutting cycle.

6 MAINTENANCE

Regular maintenance is important for safe, reliable operation.

Only those persons who have appropriate electrical knowledge (authorized personnel) may remove the safety plates.



WARNING

Ensure that the mains voltage supply to the machine has been disconnected externally. Switch off the switch at the wall socket before inspecting or working in the power source.



WARNING

Water or oil can collect in the compressed air lines. Always direct the first stream of air away from the equipment, to prevent damage.



CAUTION

All guarantee undertakings from the supplier cease to apply if the customer attempts any work to rectify any faults in the product during the guarantee period.

If the equipment does not work correctly, stop work immediately and determine the cause of the problem. Maintenance work may only be carried out by persons with the applicable knowledge. Electrical work may only be carried out by authorised electricians. Never allow persons other than those with the applicable knowledge to check, clean or repair the equipment. Only use recommended spare parts.

6.1 Inspection and cleaning

The following points on the power source should be checked and/or cleaned regularly.

1. Check the return cable connection to the work piece.
2. Check that the protective earth from the work piece is securely connected to the power source chassis earth.
3. Check the torch heat shield. Replace it if it is damaged.
4. Check the electrode and the nozzle for wear daily. Remove any splash, replace the electrode and nozzle as necessary. If the electrode has a pit which is more than 1.5 mm deep at its center, it must be replaced. If the electrode is used beyond this recommended wear limit, damage to the torch and power source may occur. Nozzle life is also greatly reduced when using the electrode below the recommended limit.
5. Check that the cables or hoses are not damaged or bent.
6. Check that all plugs and connections and ground terminals are firmly connected.
7. Ensure that all incoming power supplies are disconnected. Use goggles and face mask and blow clean the power source internally using dry compressed air at low pressure .
8. Regularly drain any water from the filter below the air regulators.

7 FAULT TRACING



WARNING

ELECTRIC SHOCKS CAN KILL Ensure that the mains voltage supply to the machine has been disconnected externally. Switch off the switch at the mains socket before inspecting or working in the power source.



WARNING

Plasma cutting equipment uses extremely high voltages that can cause severe injury or even death. Observe extreme caution when working with the covers removed.

Try these recommended checks and inspections before sending for an authorized service technician.

Type of fault	Corrective action
No arc.	<ul style="list-style-type: none"> • Check that the mains power supply switch is turned on. • Check that the current supply and return cables are correctly connected. • Check that the correct current value is set.
The current is interrupted during cutting.	<ul style="list-style-type: none"> • Check whether the thermal overload trips have operated. • Check the mains power supply fuses.
The thermal cut-out trips frequently.	<ul style="list-style-type: none"> • Make sure that you are not exceeding the rated data for the power source (i.e. that the unit is not being overloaded).
Poor cutting performance.	<ul style="list-style-type: none"> • Check that the current supply and return cables are correctly connected. • Check that the correct current value is set. • Check that the correct electrode is being used. • Check the mains power supply fuses.

If you cannot locate the problem switch off the incoming power supply, open the unit and check all components and conductors visually. Look for swollen or leaking condensers and other signs of damage or discolouration.

7.1 Fault codes

Should a fault condition exist in normal operation, the display will show a code number. All fault signals will remain on for a minimum of 10 seconds. If the fault is cleared, all will reset automatically except for over-current. To clear over-current, the power must be shut off for 5 seconds and then turned back on.

Code	Problem	Cause	Solution
1	Mains voltage, idle +/- 15 %	Incoming mains voltage may have fallen below or risen above the set nominal value.	Check the mains voltage.
2	Mains voltage, cutting +/- 20 %	Incoming mains voltage may have fallen below or risen above the set nominal value during ongoing cutting.	Check the mains voltage.
3	Operating pre-tensioning, +/- 15 V pre-tensioning distribution	The operating circuit transformer does not supply the correct voltage to the operating circuits.	Check the transformer and control board.
4	Thermal switches	Thermal switches off – equipment overheated.	Let the equipment cool. Check that the ventilation is adequate.
5	Pressure	The air pressure is outside the permitted interval., min 5.1 bar and max 6.5 bar.	Check the supply compressed air and pressure setting.
6	The arc does not strike.	Arc transfer could not occur.	Check the ground lead.
7	Pilot arc time limit (approx 5 seconds) exceeded.	The cutting process did not begin with the 5 second limit.	Start within 5 seconds:
8	Torch fault	The electrode touches the nozzle (cannot separate).	Check/replace consumables.
10	Reconnection problem.	The problem primarily occurs if the hall sensor is not connected.	Check the cable connection between the current sensor board and the control board. Check the torch for a short circuit between the nozzle and the work piece. Remove any scrap from the front section of the torch.
11	Over current on the primary side.	Converter fault.	Send the unit to the authorised service workshop for repair.
12	Phase drop, switch off, on the primary side (mains supply)	Exceeded single phase duty cycle rating	Check the mains power supply fuses.
13	Open circuit voltage fault	Neither voltage nor current could be detected at automatic Parts In Place (PIP) check of consumables.	Send the unit to the authorised service workshop for repair.
14	Overtemperature in the apparatus sheath.	The temperature is higher than the permitted operational limit.	Check the ventilation around the unit. Check the cooling air gaps and ensure that any obstacles are removed from there.

Code	Problem	Cause	Solution
15	Bus charging fault	Under voltage on the primary bus.	Check the bus charger.
19	Torch trigger early engagement	Torch trigger depressed at power up.	Check the trigger.
20	No return at PIP (Parts In Place) check of consumables.	The piston was not withdrawn when air was released.	Check/clean consumables. Check the compressed air supply.
21	No unbroken current path at PIP (Parts In Place) check of consumables.	The piston did not fall back when the air supply was removed.	Check/clean consumables.

8 ORDERING SPARE PARTS

Repair and electrical work should be performed by an authorised ESAB service technician. Use only ESAB original spare and wear parts.

Powercut 900 is designed and tested in accordance with the international and European standards 60974-1 and 60974-10. It is the obligation of the service unit which has carried out the service or repair work to make sure that the product still conforms to the said standard.

Always provide the serial number of the unit on which the parts will be used. The serial number is stamped on the units rating plate.

Spare parts may be ordered through your nearest ESAB dealer, see the last page of this publication.

Diagram

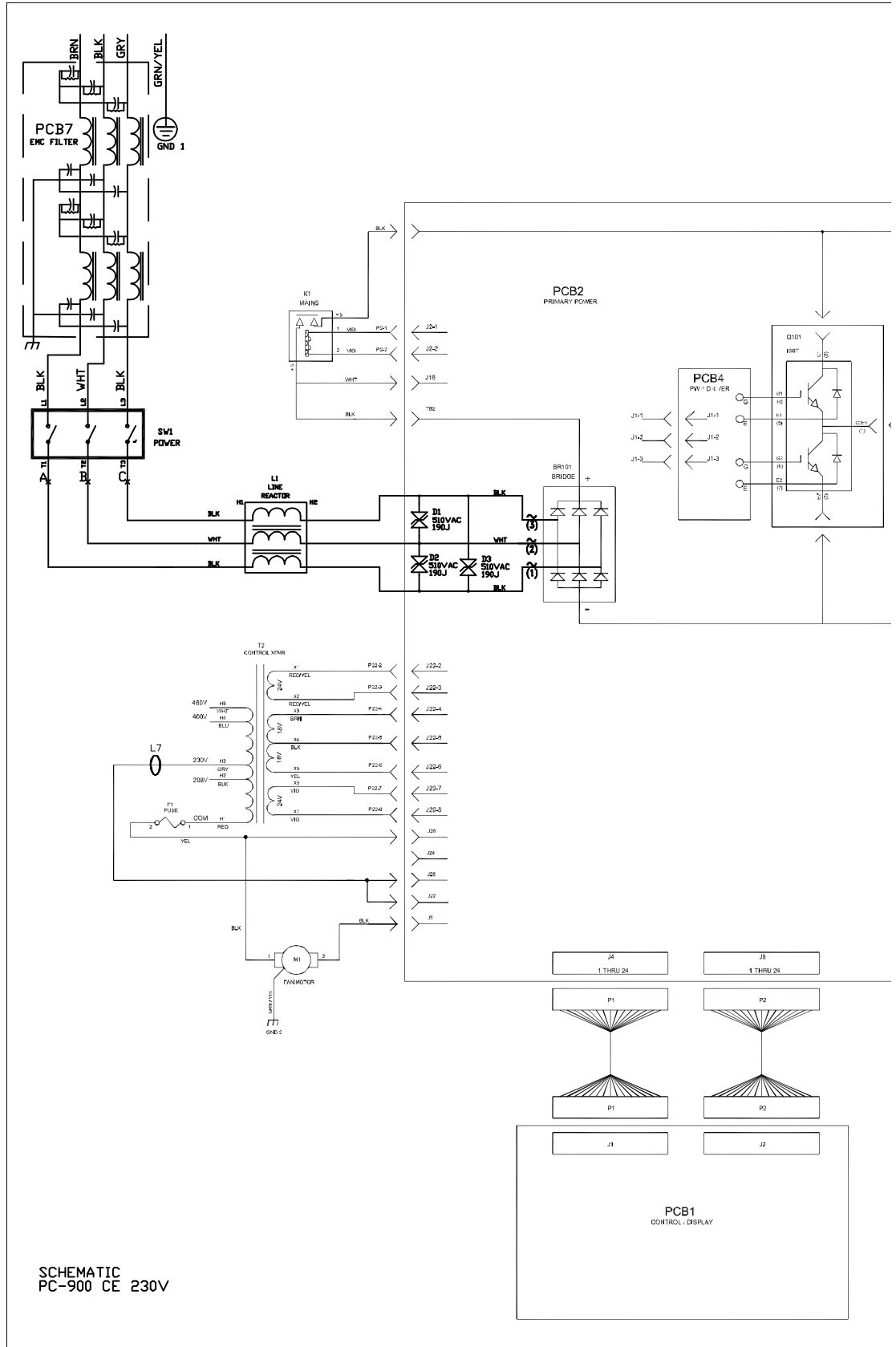

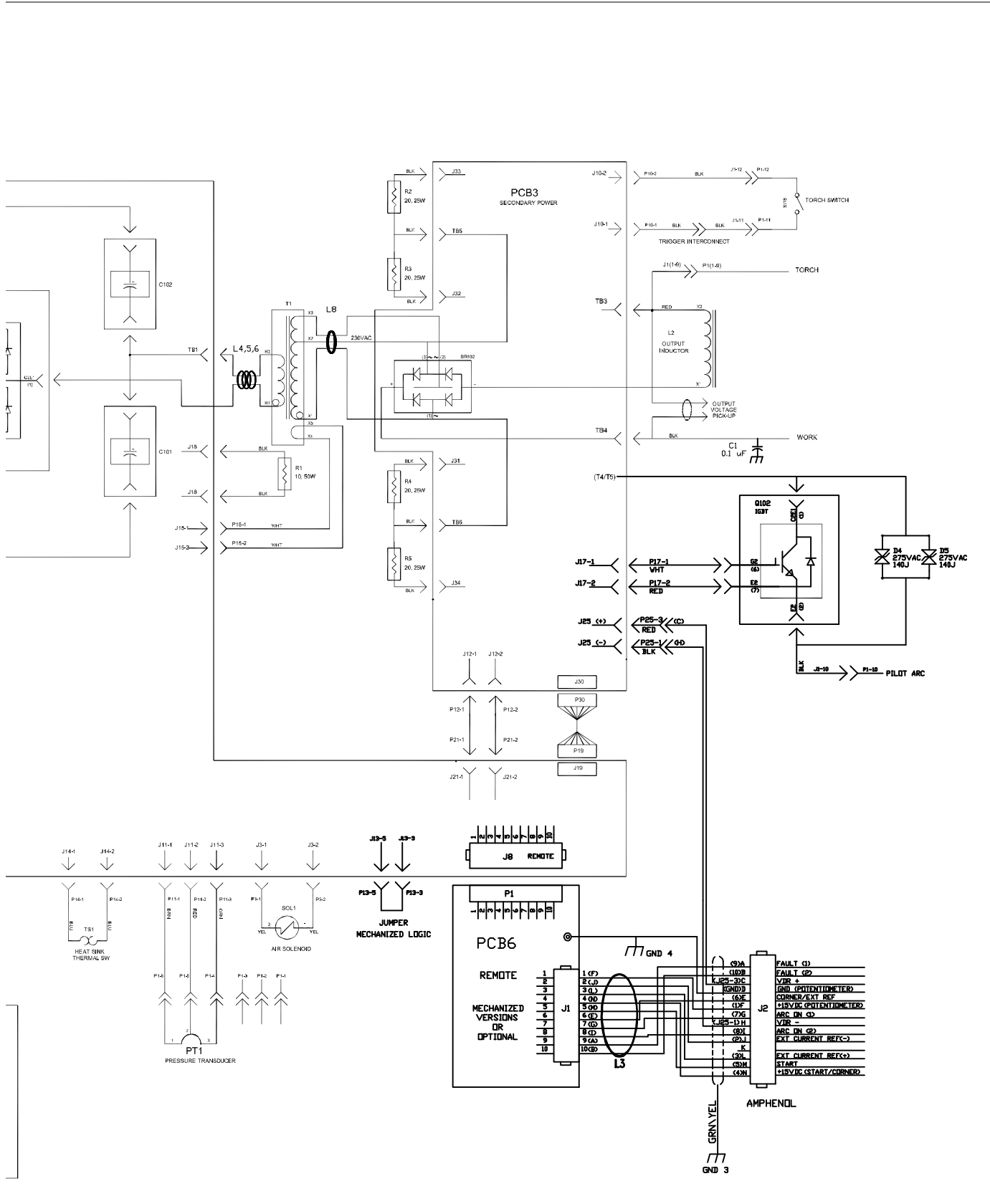

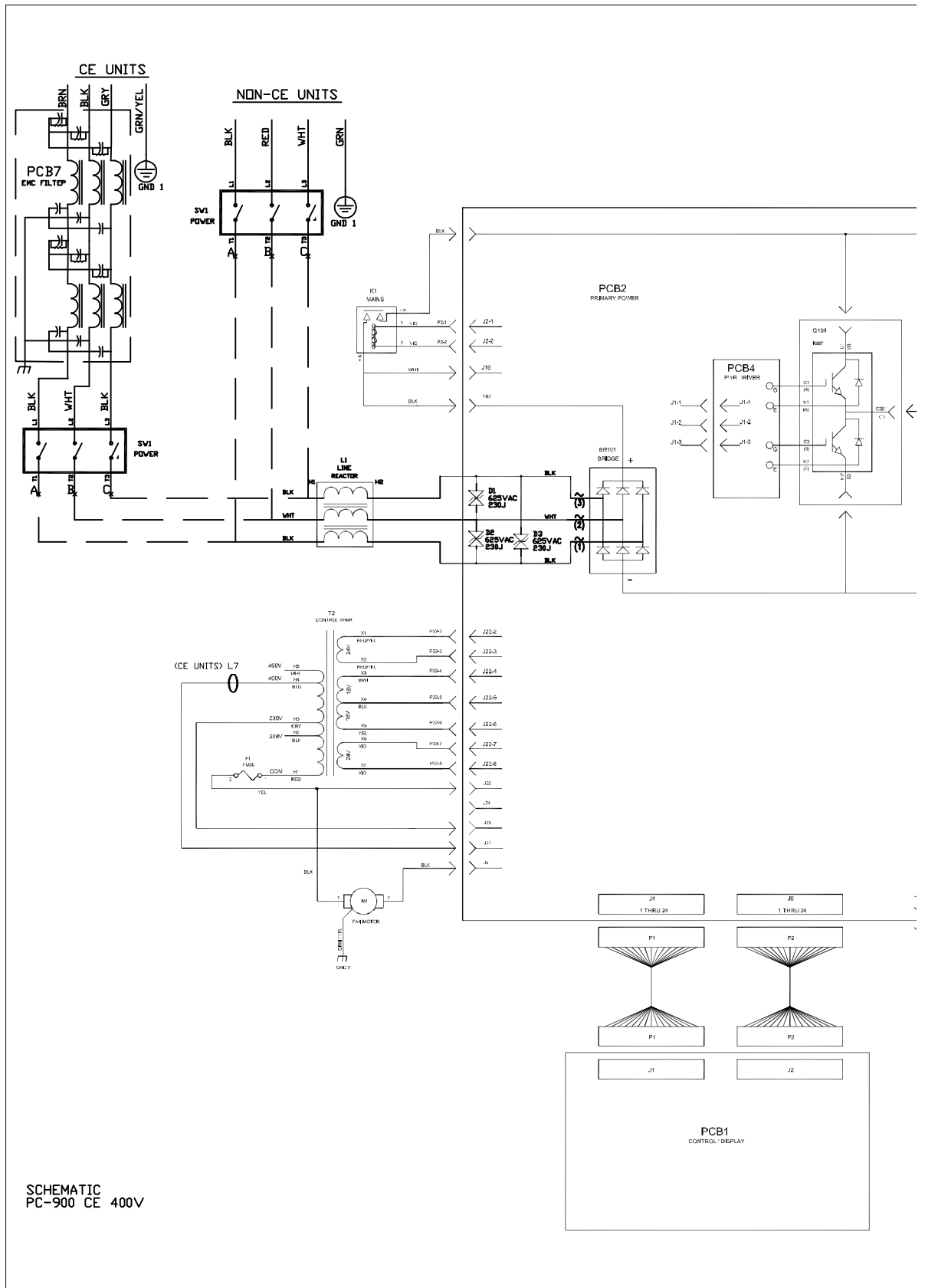

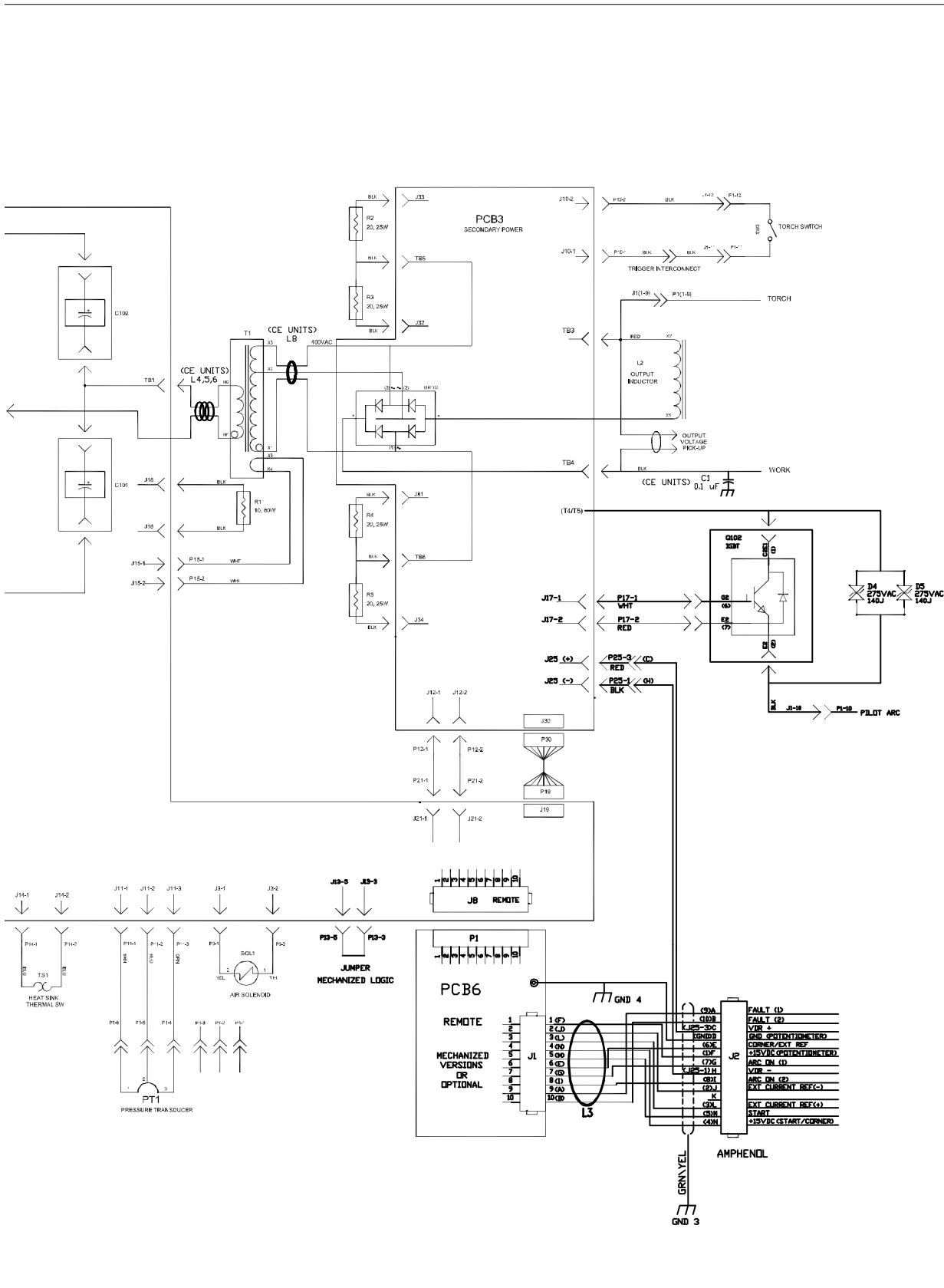

Powercut 900





Order number



Ordering no.	Denomination	Type	Notes
0558 008 123	Power source for plasma cutting	Powercut™ 900	230 V
0558 008 124	Power source for plasma cutting and torch	Powercut™ 900 + PT 38	230 V
0558 008 135	Power source for plasma cutting	Powercut™ 900	400 V
0558 008 136	Power source for plasma cutting and torch	Powercut™ 900 + PT 38	400 V
0558 006 786	Torch	PT38	7.5 m

Powercut 900

Accessories

	Trolley 0558 007 898
	Gas flow measuring kit 0558 000 739
	Water separator 0558 007 897
	PT38 torch, 15.2 m 0558 006 787

NOTES

Dotted lines for writing notes.

ESAB subsidiaries and representative offices

Europe

AUSTRIA

ESAB Ges.m.b.H
Vienna-Liesing
Tel: +43 1 888 25 11
Fax: +43 1 888 25 11 85

BELGIUM

S.A. ESAB N.V.
Brussels
Tel: +32 2 745 11 00
Fax: +32 2 745 11 28

BULGARIA

ESAB Kft Representative Office
Sofia
Tel/Fax: +359 2 974 42 88

THE CZECH REPUBLIC

ESAB VAMBERK s.r.o.
Vamberk
Tel: +420 2 819 40 885
Fax: +420 2 819 40 120

DENMARK

Aktieselskabet ESAB
Herlev
Tel: +45 36 30 01 11
Fax: +45 36 30 40 03

FINLAND

ESAB Oy
Helsinki
Tel: +358 9 547 761
Fax: +358 9 547 77 71

FRANCE

ESAB France S.A.
Cergy Pontoise
Tel: +33 1 30 75 55 00
Fax: +33 1 30 75 55 24

GERMANY

ESAB GmbH
Solingen
Tel: +49 212 298 0
Fax: +49 212 298 218

GREAT BRITAIN

ESAB Group (UK) Ltd
Waltham Cross
Tel: +44 1992 76 85 15
Fax: +44 1992 71 58 03

ESAB Automation Ltd
Andover
Tel: +44 1264 33 22 33
Fax: +44 1264 33 20 74

HUNGARY

ESAB Kft
Budapest
Tel: +36 1 20 44 182
Fax: +36 1 20 44 186

ITALY

ESAB Saldatura S.p.A.
Bareggio (Mi)
Tel: +39 02 97 96 8.1
Fax: +39 02 97 96 87 01

THE NETHERLANDS

ESAB Nederland B.V.
Amersfoort
Tel: +31 33 422 35 55
Fax: +31 33 422 35 44

NORWAY

AS ESAB
Larvik
Tel: +47 33 12 10 00
Fax: +47 33 11 52 03

POLAND

ESAB Sp.zo.o.
Katowice
Tel: +48 32 351 11 00
Fax: +48 32 351 11 20

PORTUGAL

ESAB Lda
Lisbon
Tel: +351 8 310 960
Fax: +351 1 859 1277

ROMANIA

ESAB Romania Trading SRL
Bucharest
Tel: +40 316 900 600
Fax: +40 316 900 601

RUSSIA

LLC ESAB
Moscow
Tel: +7 (495) 663 20 08
Fax: +7 (495) 663 20 09

SLOVAKIA

ESAB Slovakia s.r.o.
Bratislava
Tel: +421 7 44 88 24 26
Fax: +421 7 44 88 87 41

SPAIN

ESAB Ibérica S.A.
Alcalá de Henares (MADRID)
Tel: +34 91 878 3600
Fax: +34 91 802 3461

SWEDEN

ESAB Sverige AB
Gothenburg
Tel: +46 31 50 95 00
Fax: +46 31 50 92 22

ESAB international AB
Gothenburg

Tel: +46 31 50 90 00
Fax: +46 31 50 93 60

SWITZERLAND

ESAB AG
Dietikon
Tel: +41 1 741 25 25
Fax: +41 1 740 30 55

UKRAINE

ESAB Ukraine LLC
Kiev
Tel: +38 (044) 501 23 24
Fax: +38 (044) 575 21 88

North and South America

ARGENTINA

CONARCO
Buenos Aires
Tel: +54 11 4 753 4039
Fax: +54 11 4 753 6313

BRAZIL

ESAB S.A.
Contagem-MG
Tel: +55 31 2191 4333
Fax: +55 31 2191 4440

CANADA

ESAB Group Canada Inc.
Mississauga, Ontario
Tel: +1 905 670 02 20
Fax: +1 905 670 48 79

MEXICO

ESAB Mexico S.A.
Monterrey
Tel: +52 8 350 5959
Fax: +52 8 350 7554

USA

ESAB Welding & Cutting Products
Florence, SC
Tel: +1 843 669 44 11
Fax: +1 843 664 57 48

Asia/Pacific

CHINA

Shanghai ESAB A/P
Shanghai
Tel: +86 21 2326 3000
Fax: +86 21 6566 6622

INDIA

ESAB India Ltd
Calcutta
Tel: +91 33 478 45 17
Fax: +91 33 468 18 80

INDONESIA

P.T. ESABindo Pratama
Jakarta
Tel: +62 21 460 0188
Fax: +62 21 461 2929

JAPAN

ESAB Japan
Tokyo
Tel: +81 45 670 7073
Fax: +81 45 670 7001

MALAYSIA

ESAB (Malaysia) Snd Bhd
USJ
Tel: +603 8023 7835
Fax: +603 8023 0225

SINGAPORE

ESAB Asia/Pacific Pte Ltd
Singapore
Tel: +65 6861 43 22
Fax: +65 6861 31 95

SOUTH KOREA

ESAB SeAH Corporation
Kyungnam
Tel: +82 55 269 8170
Fax: +82 55 289 8864

UNITED ARAB EMIRATES

ESAB Middle East FZE
Dubai
Tel: +971 4 887 21 11
Fax: +971 4 887 22 63

Africa

EGYPT

ESAB Egypt
Dokki-Cairo
Tel: +20 2 390 96 69
Fax: +20 2 393 32 13

SOUTH AFRICA

ESAB Africa Welding & Cutting Ltd
Durbanville 7570 - Cape Town
Tel: +27 (0)21 975 8924

Distributors

For addresses and phone numbers to our distributors in other countries, please visit our home page

www.esab.com



www.esab.com

